

すうじをおぼえよう(つくえ)

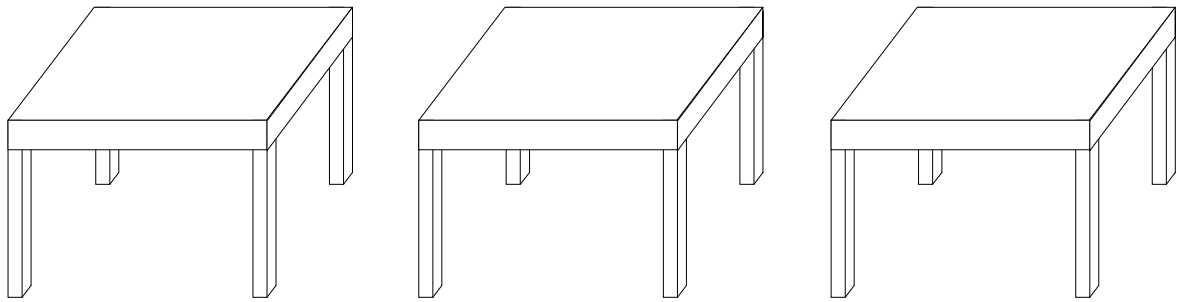
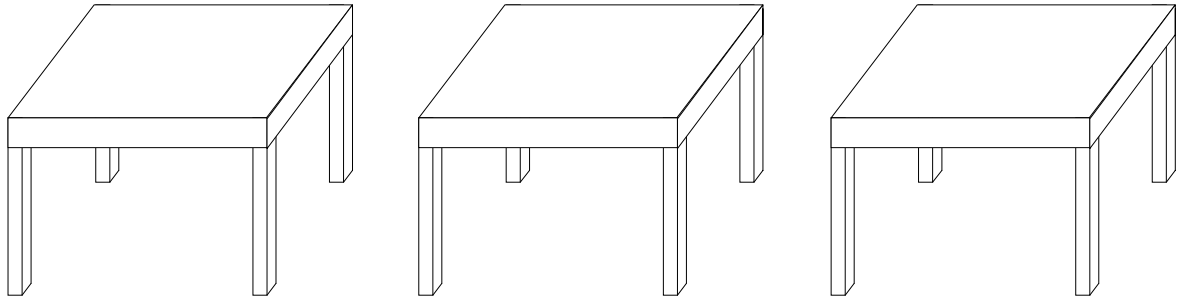

6	6	6	6	6
6	6	6	6	6
+	+	+		