

すうじをおぼえよう(つくえ)

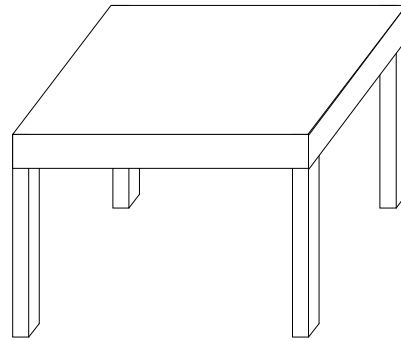
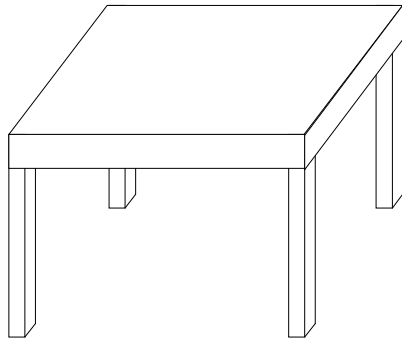
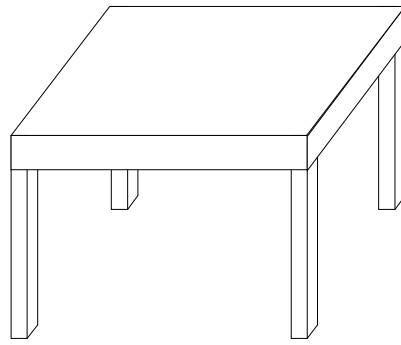

3	3	3	3	3
3	3	3	3	3
+	+	+		